

SEGA CIRCOLARE - SQUADRATRICE A LAMA INCLINABILE
 CIRCULAR - SAW WITH TILTING BLADE
 SCHRÄGSTELLBAR KREISSÄGE
 SCIE CIRCULAIRE - EQUARRISSEUSE A LAME INCLINABLE
 SIERRA CIRCULAR - ESCUADRADORA DE HOJA INCLINABLE



DATI TECNICI TECHNICAL DATA TECHNISCHE DATEN		S315-1500	S315-2000	S315-2500	DONNES TECHNIQUES DATOS TÉCNICOS	
Dimensioni piano fisso Working table size Gubeisen Arm Arbeitsfläche	mm mm mm	775 x 555	775 x 555	775 x 555	Dimensions de la table Dimensiones mesa fija	mm mm
Dimensioni carrello Sliding table dimension Tischgröße	mm mm mm	1500 x 300	2000 x 300	2500 x 300	Dimensions du chariot Dimensiones carro en aluminio	mm mm
Lunghezza max di squadratura Max crosscutting capacity Schnittlänge	mm mm mm	1600	2100	2600	Longueur effective de sciage Largo max a esquadrar	mm mm
Dimensioni telaio squadra Squaring fence frame dimension Winkelrahmen	mm mm mm	900 x 550	900 x 550	900 x 550	Cadre de suspensions equerre Dimensiones bastidor escuadra	mm mm
Ø Lama Saw blade diameter Ø der Säge	mm mm mm	300	300	300	Ø Lame Ø disco sierra	mm mm
Ø Albero lama Saw blade arbor diameter Ø der Welle	mm mm mm	30	30	30	Ø de l'arbre porte - lame Ø eje disco	mm mm
Inclinazione lama Saw blade tilting Sägeblattneigung		0° - 45°	0° - 45°	0° - 45°	Inclinaison de la lame Inclinacion del disco	
Altezza taglio a 90° Max dept of cut at 90° Schnitthöhe mit Sägeblatt zu 90°		102	102	102	Hauteur de coupe de la lame Alto de corte a 90°	
Altezza taglio a 45° Max dept of cut at 45° Schnitthöhe mit Sägeblatt zu 45°		72	72	72	Hauteur de coupe de la lame a 45° Alto de corte a 45°	
Potenza motore Saw blade motor power Motorstärke	HP HP PS	HP 4 kW 3	HP 4 kW 3	HP 4 kW 3	Puissance du moteur Potencia motor disco	CV HP
Velocità lama Saw blade rotation speed Drehzahl der Sägewelle	g/min rpm U/min	4000	4000	4000	Vitesse de rotation de la lame Velocidad rotación disco	t/min rpm
Emissione rumori Noise level Arbeitsplatzbezogene Emission werte	db(A) db(A) db(A)	85,7	85,7	85,7	Pression acoustique Emisión rumor	db(A) db(A)
Peso netto Net weight Gewicht netto	Kg Kg Kg	528	535	542	Poids net Peso neto	Kg Kg
Dimensioni imballo: LM+LR+A Packing size: L+W+H Verpackungsmasse: L+B+H		1700 x 1100 x 1050	2200 x 1100 x 1050	2700 x 1100 x 1050	Dimensions emballage: LN+LR+H Dimensiones embalaje: L+AN+AI	

SU RICHIESTA UPON REQUEST SONDERZUBEHÖR					SUR DEMANDE SOBRE PEDIDO	
Gruppo incisore Scoring unit Vorritzaggregat					Inciseur Grupo incisor	
Ø Lama incisore Scoring blade diameter Ø der Vorritzwelle durchmesser	mm mm mm	80	80	80	Ø de la lame de l'inciseur Ø disco incisor	mm mm
Velocità incisore Scoring blade rotation speed Drehzahl der Vorritzaggregat	g/min rpm U/min	8000	8000	8000	Vitesse de la lame de l'inciseur Velocidad rotacion incisor	t/min rpm
Ø Albero incisore Saw blade arbor diameter Ø der Welle Vorritzaggregat	mm mm mm	20	20	20	Ø de l'arbre porte inciseur Ø eje incisor	mm mm
Potenza motore Saw blade motor power Motorstärke	HP HP PS	HP 5,5 kW 4	HP 5,5 kW 4	HP 5,5 kW 4	Puissance du moteur Potencia motor disco	CV HP
Ø Lama Saw blade diameter Ø der Säge	mm mm mm	315	315	315	Ø Lame Ø Disco sierra	mm mm



SEGA CIRCOLARE - SQUADRATRICE A LAMA INCLINABILE





CIRCULAR - SAW WITH TILTING BLADE

SCHRÄGSTELLBAR KREISSÄGE

SCIE CIRCULAIRE - EQUARRISSEUSE A LAME INCLINABLE

SIERRA CIRCULAR - ESCUADRADORA DE HOJA INCLINABLE

S 315

-  **DOTAZIONE STANDARD**
-  **STANDARD EQUIPMENT**
-  **STANDARD AUSRÜSTUNG**
-  **DOTATION STANDARD**
-  **EQUIPAMIENTO DE SERIE**

tecnica
PAOLONI GROUP
S 315

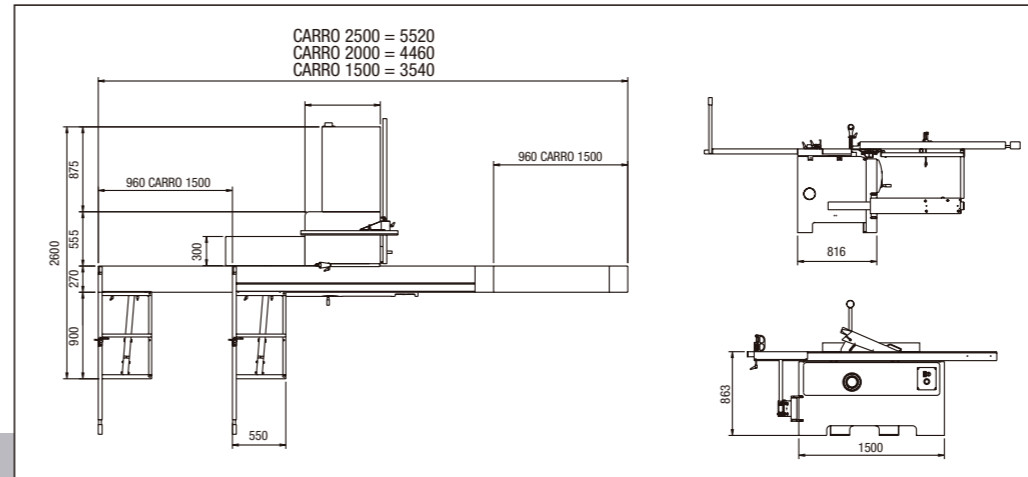

-  **SU RICHIESTA**
-  **UPON REQUEST**
-  **SONDERZUBEHÖR**
-  **SUR DEMANDE**
-  **SOBRE PEDIDO**

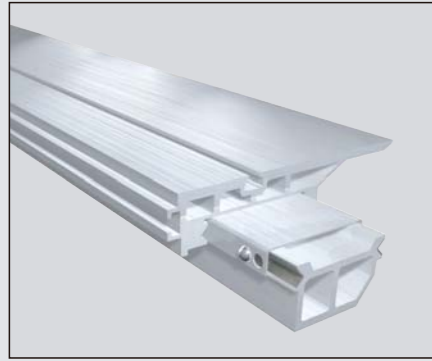

Gruppo incisore
Scoring unit
Vorritzaggregat
Groupe Inciseur
Grupo incisor



Guida per taglio pezzi corti
Angular cutting device
Gehrungsanschlag für kleine Werkstücke
Guide pour coupe de pièces courtes
Escuadra para corte de piezas pequeñas



- VERSIONE
- EQUIPMENT
- AUSFÜHRUNG
- EQUIPMENT
- EQUIPAMIENTO