

CNC-Bearbeitungszentrum

**SPRINT M / R**



# Frontansicht



# Beispiel einer Sonderausführung



# Seitenansicht

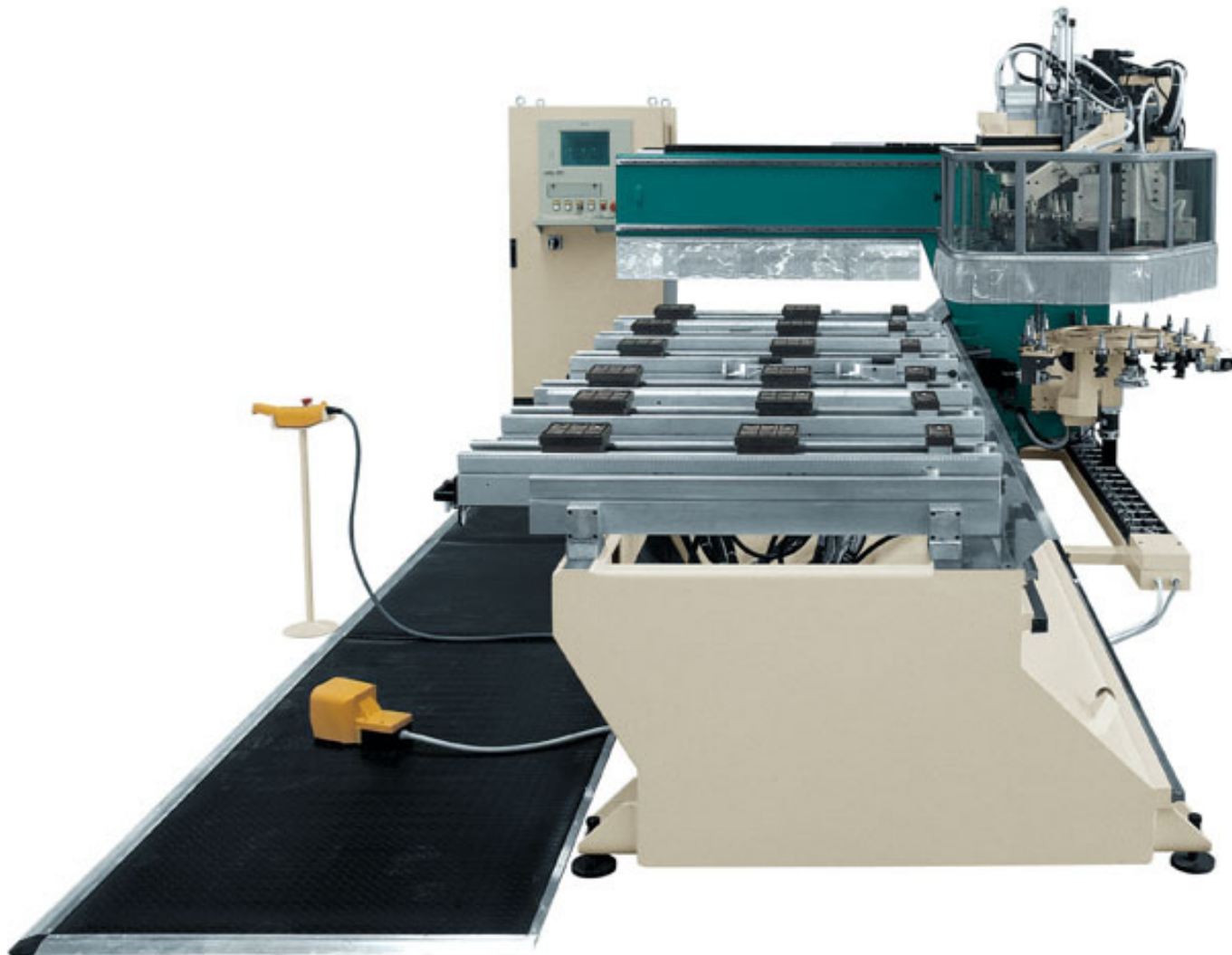

# Bearbeitungseinheiten



# Aufbau

- ◆ Moderne Stahlbauweise in verwindungssteifer Ausführung bearbeitet in einem einzigen Vorgang um eine hervorragende Qualität bzw. Präzision zu gewähren



# Wagen für Bearbeitungsaggregat

- ✦ Der in X verfahrenende Cantileverwagen ist in verwindungssteifer Stahlbauweise konstruiert und gewährt höchste Qualität
- ✦ Die Z-Achse verfährt auf Kugelumlaufführungen und ist zusätzlich mit einem Gewichtsausgleich zylinder ausgestattet



# Werkzeugwechsler 3/8/18 Plätzen

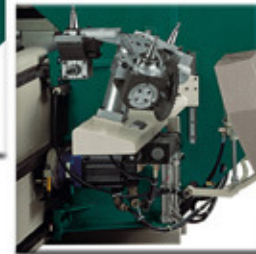
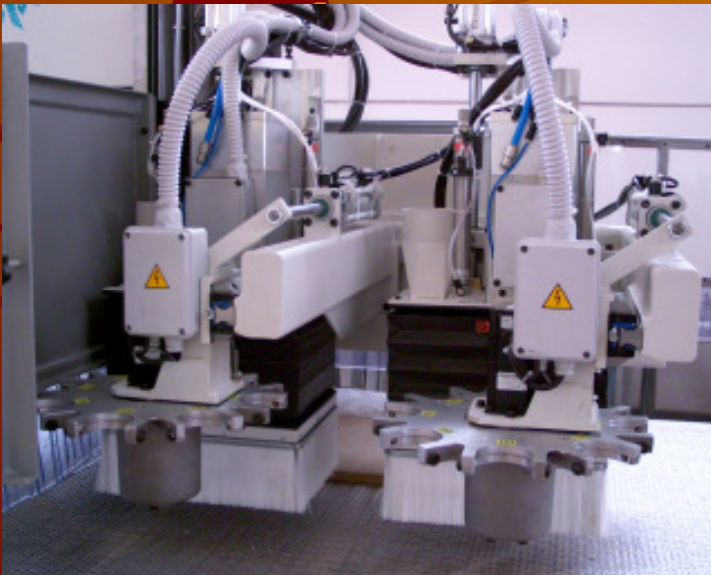
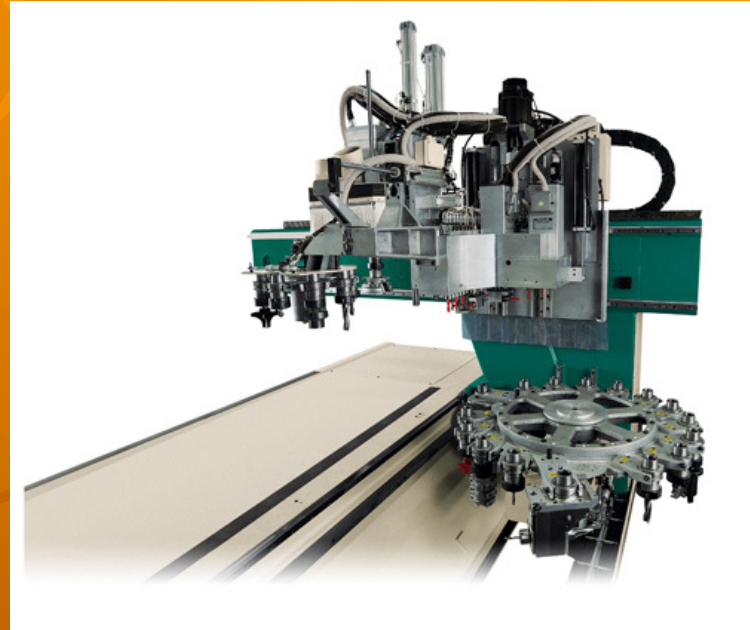
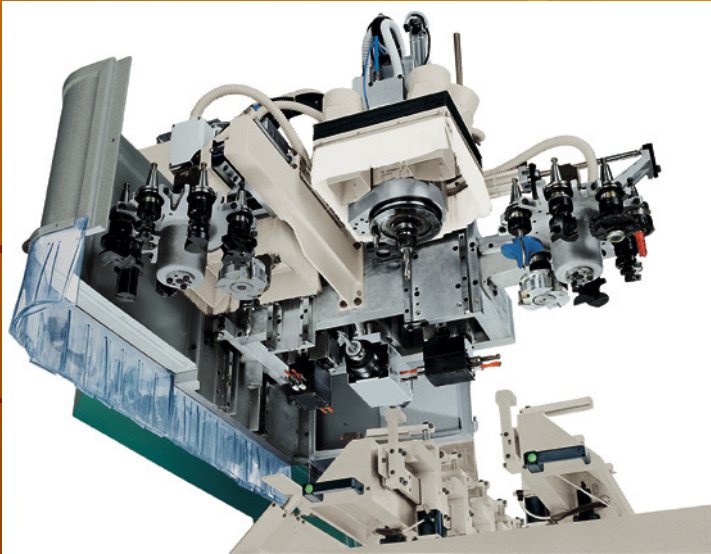





# Winkelaggregate



# Saugbalken bzw. Arbeitstische



# “Step-Sauger”

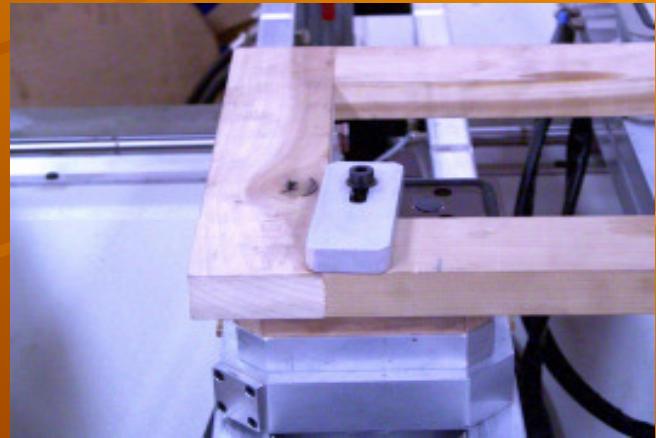
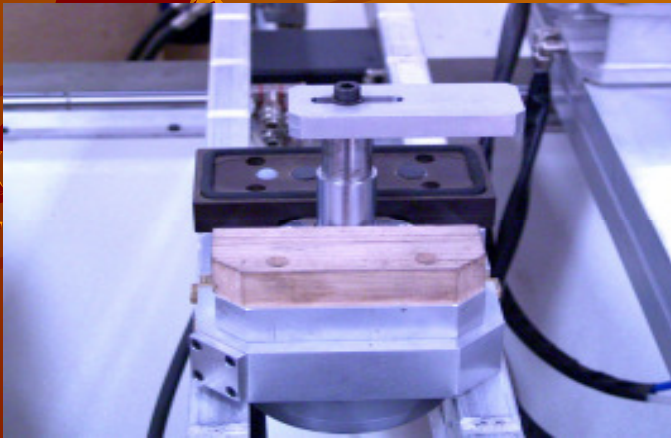
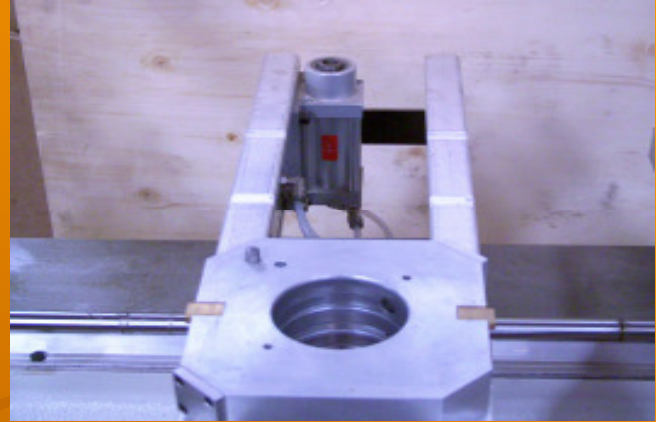
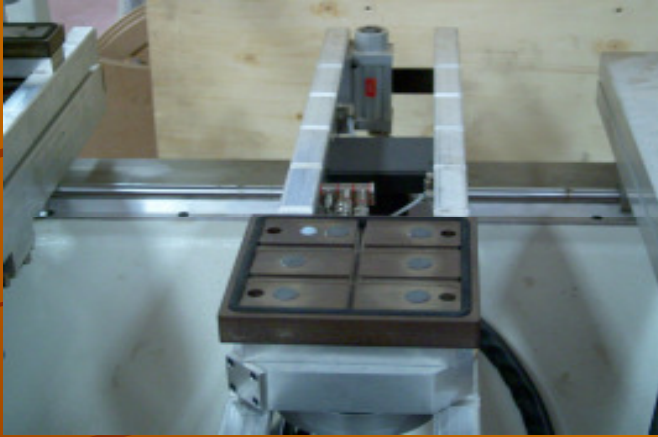

# Sonderblockiersysteme für besondere Bedürfnisse



# “Step-Sauger”: absolute Vielseitigkeit

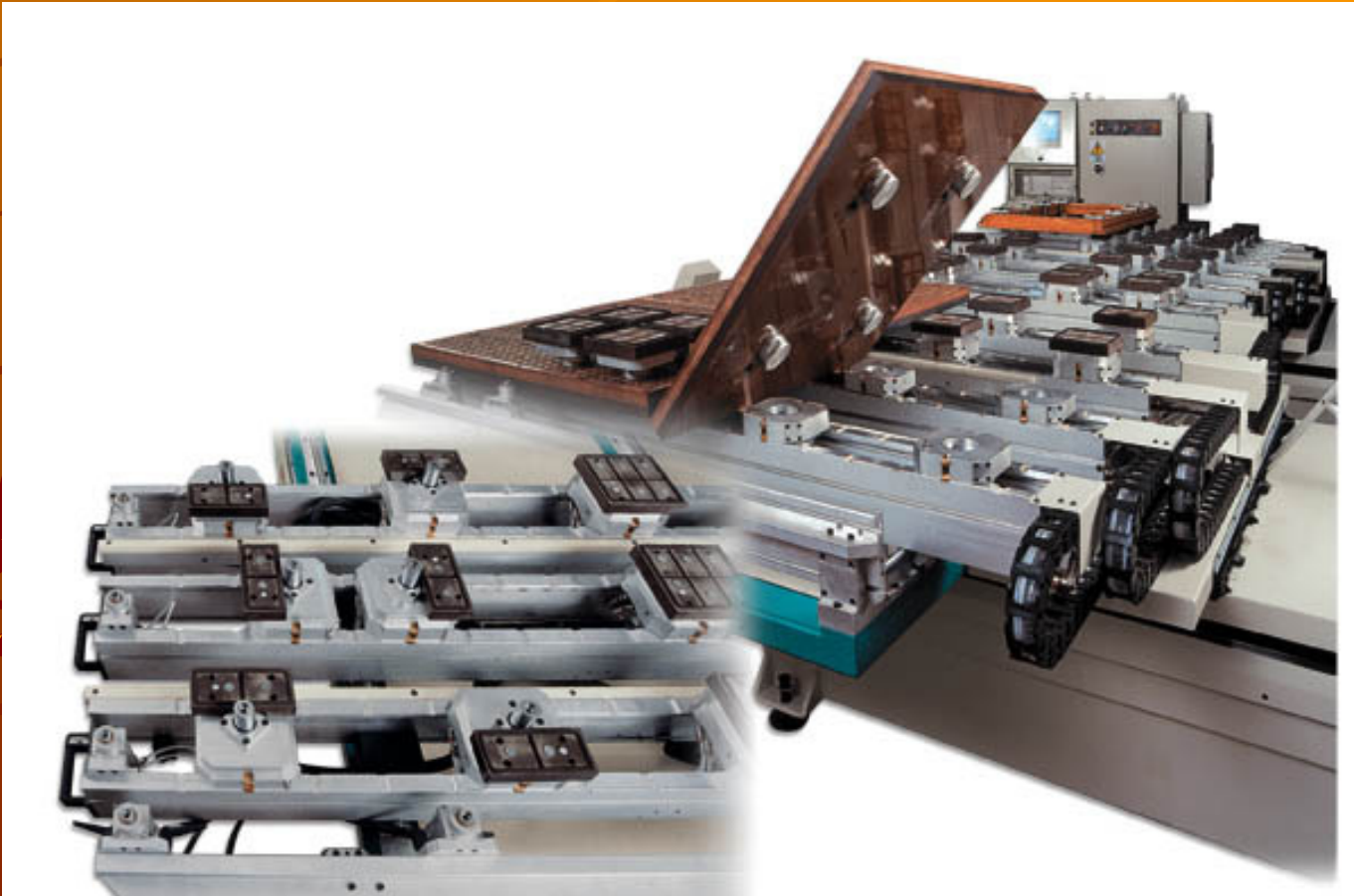

# Digitale Positionsanzeige für Saugbalken und Sauger

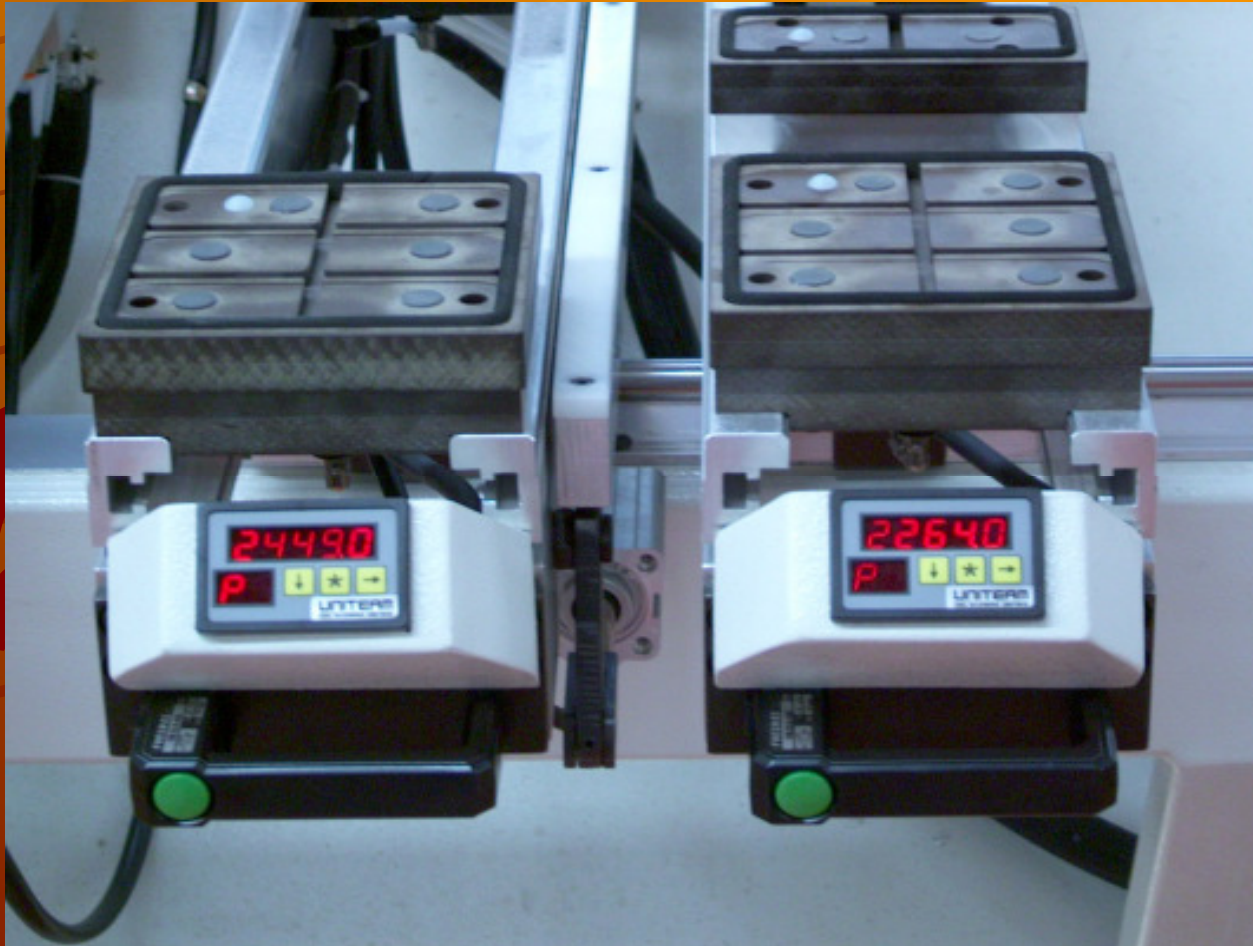

# Arbeitsbereich Z-Achse

MANDRINO  
VERTICALE

MANDRINO  
ORIZZONTALE

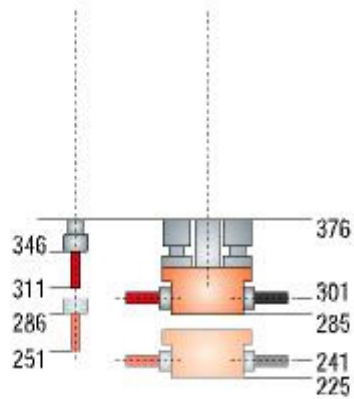

Z  
250 mm

SINISTRO DESTRO

GRUPPO LAMA

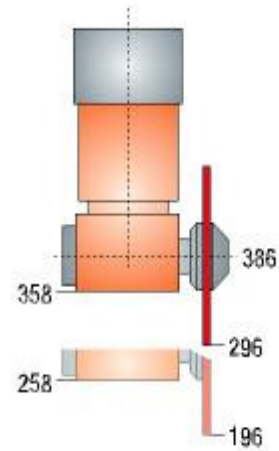

FRESATORE  
VERTICALE Kw 7,5

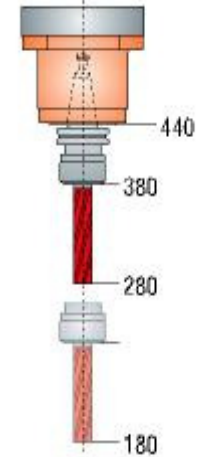

MAX. 170

0

# Lieferbare Ausführungen

