

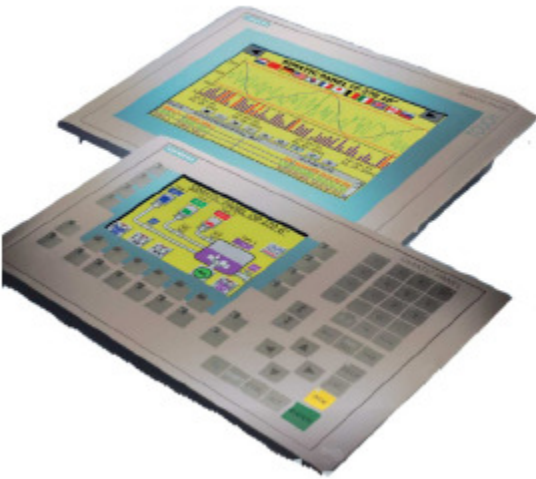

MAXX



Abmessungen



ingombro



Maschine dimensions

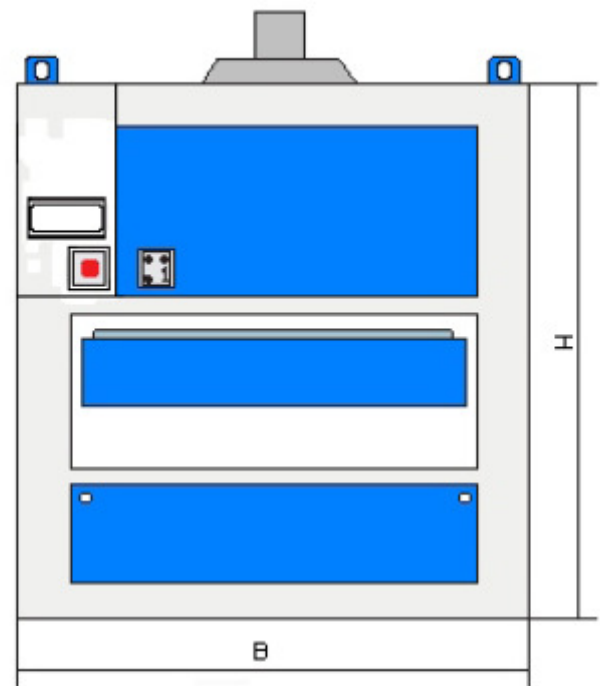
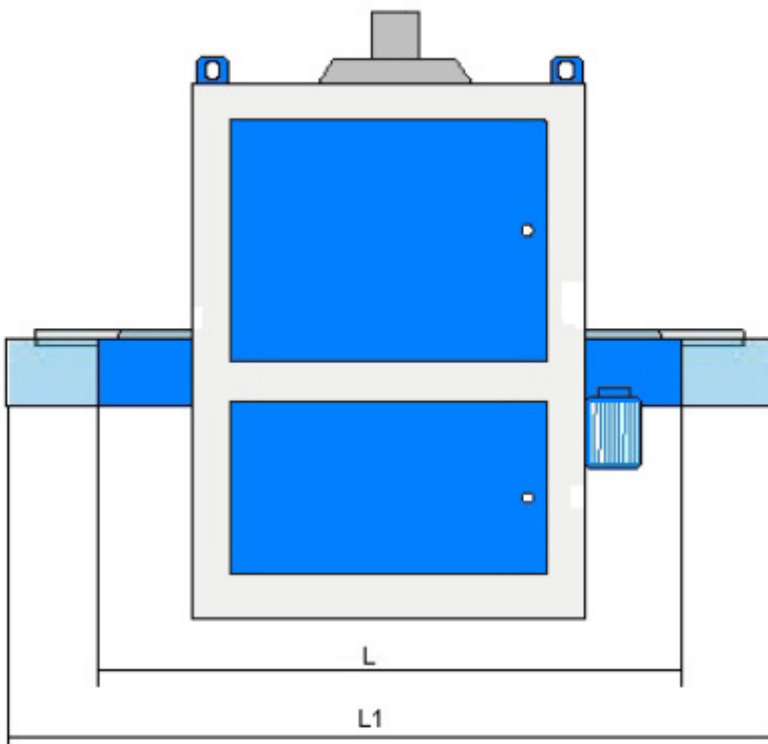

MAXX		R	C	RR	RC	RRR	RRC	RP	RRP
1 300	B	1 960	1 960	1 960	1 960	1 960	1 960	1 960	1 960
1 300	H	2 200	2 200	2 200	2 200	2 200	2 200	2 200	2 200
1 300	L	1 750	1 750	2 085	2 085	2 395	2 395	2 085	2 395
1 300	L1	2 060	2 060	2 395	2 395	2 705	2 705	2 395	2 705
1 100	B	1 760	1 760	1 760	1 760	1 760	1 760	1 760	1 760
1 100	H	2 200	2 200	2 200	2 200	2 200	2 200	2 200	2 200
1 100	L	1 750	1 750	2 085	2 085	2 395	2 395	2 085	2 395
1 100	L1	2 060	2 060	2 395	2 395	2 705	2 705	2 395	2 705

MAXX



Konfiguration der Schleifeinheiten



Configurazione del gruppo abrasivo



Configurator of sanding units

R

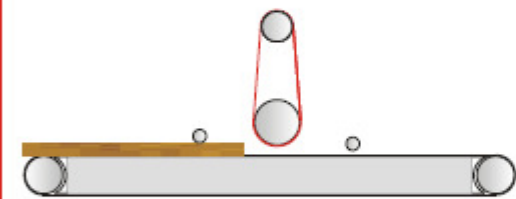

C

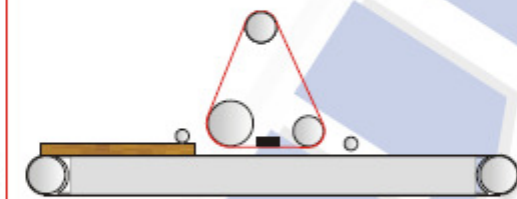

RR

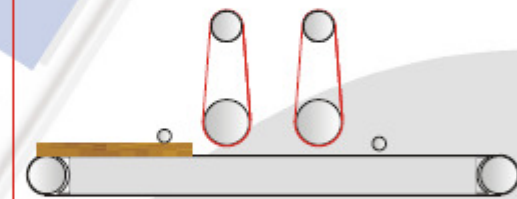

RC

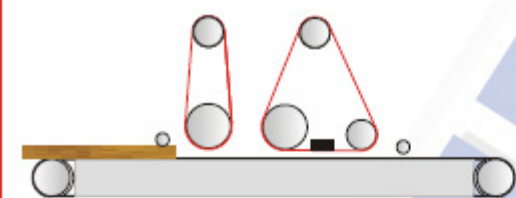

RRR

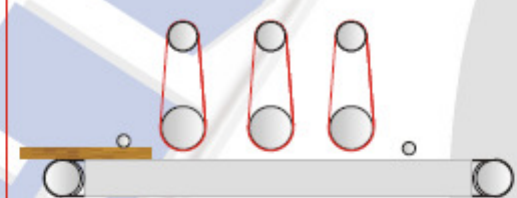

RRC

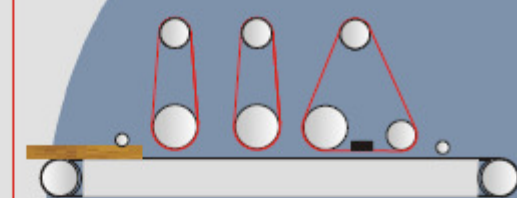

RP

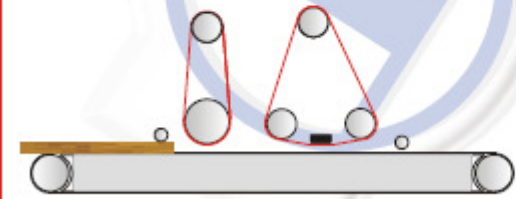

RRP

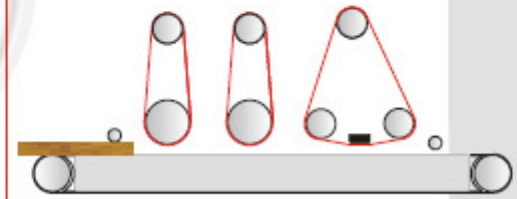

MAXX



TECHNICKÁ DATA



TECHNICAL DATA



TECHNISCHE DATEN

MAXX		1 100 R/C	1 300 R/C	1 100 RR/RC	1 300 RR/RC	1 100 RRR/RRC	1 300 RRR/RRC	1 100 RP/RRP	1 300 RP/RRP	1 100 Industry RRC	1 300 Industry RRC
Pracovní šířka Working width Arbeitsbreite	mm	1100	1300	1100	1300	1100	1300	1100	1300	1100	1300
Průměr pracovních válců Diameter of working roller Durchmesser der Arbeitswalze	mm	240	240	240	240	240	240	240	240	240	240
Šířka pásu Width of the belt Schleifbandbreite	mm	1120	1320	1120	1320	1120	1320	1120	1320	1120	1320
Délka pásu Length of the belt Schleifbandlänge	mm	2650	2650	2650	2650	2650	2650	2650	2650	2650	2650
Rychlost brusného pásu Speed of sanding belt Schleifbandgeschwindigkeit	m/sec.	18,5	18,5	18,5	18,5	18,5	18,5	18,5	18,5	18,5	18,5
Výška obrábku (max. / min.) Height of workpiece (max. / min.) Arbeitshöhe (max. / min.)	mm	160/3	160/3	160/3	160/3	160/3	160/3	160/3	160/3	160/3	160/3
Rychlost posuvu Speed of conveyor belt Teppichgeschwindigkeit	m/min.	3-12	3-12	3-12	3-12	3-12	3-12	3-12	3-12	3-12	3-12
Výkon motoru brusného pásu Motor power of sanding belt Schleifbandmotorleistung	kW	15	18	15	18	15	18	15	18	15	18
Doporučené jističi - série C,D Recommended protection - series C,D Empfohlene Sicherung - Serie C,D	A	63/80-100	63/80-100	63/80-100	63/80-100	63/80-100	63/80-100	63/80-100	63/80-100	63/80-100	63/80-100
Výkon motoru posuvu Motor power of conveyor belt Leistung Teppichgesch. Motor	kW	0,55	0,55	0,55	0,55	0,55	0,55	0,55	0,55	0,55	0,55
Výkon motoru zdvihu stolu Power of the table lifting motor Tischhubmotorleistung	kW	0,18	0,18	0,18	0,18	0,18	0,18	0,18	0,18	0,18	0,18
Připojka Voltage Anschlussspannung	V/Hz	3x400V/50Hz	3x400V/50Hz	3x400V/50Hz	3x400V/50Hz	3x400V/50Hz	3x400V/50Hz	3x400V/50Hz	3x400V/50Hz	3x400V/50Hz	3x400V/50Hz
Tlak pracovního vzduchu Air input of operating pressure Pneumatischer Betriebsdruck	BAR	5,5	5,5	5,5	5,5	5,5	5,5	5,5	5,5	5,5	5,5
Max vzduchu pro otlak Input operating pressure for belt blower Eintrittsbetriebsdruck für	BAR	8	8	8	8	8	8	8	8	8	8
Průměr odvětrávacího hrdla Exhaust tube diameter Durchmesser des Abaugungshülses	mm	1x180	1x180	2x180	2x180	3x180	3x180	2-3x180	2-3x180	3x180	3x180